



KONICA MINOLTA

NEW

CHLOROPHYLL METER SPAD-502Plus

A lightweight handheld meter for measuring the chlorophyll content of leaves without causing damage to plants.



The essentials of imaging



The SPAD-502Plus is a compact meter

designed to help users improve crop quality and increase crop yield by providing an indication of the amount of chlorophyll present in plant leaves. The chlorophyll content of plant leaves is related to the condition of the plant, and thus can be used to determine when additional fertilizer is necessary. By optimizing nutrient conditions, healthier plants can be grown, resulting in a larger crop yield of higher quality.

Theory

The SPAD-502Plus determines the relative amount of chlorophyll present by measuring the absorbance of the leaf in two wavelength regions.

The graph below shows the spectral absorbance of chlorophyll extracted from two leaf samples using 80% acetone.

From the diagram, it can be seen that chlorophyll has absorbance peaks in the blue (400-500 nm) and red (600-700 nm) regions, with no absorbance in the near-infrared region.

To take advantage of this characteristic of chlorophyll, the SPAD-502Plus measures the absorbances of the leaf in the red and near-infrared regions. Using these two absorbances, the meter calculates a numerical SPAD value which is proportional to the amount of chlorophyll present in the leaf.

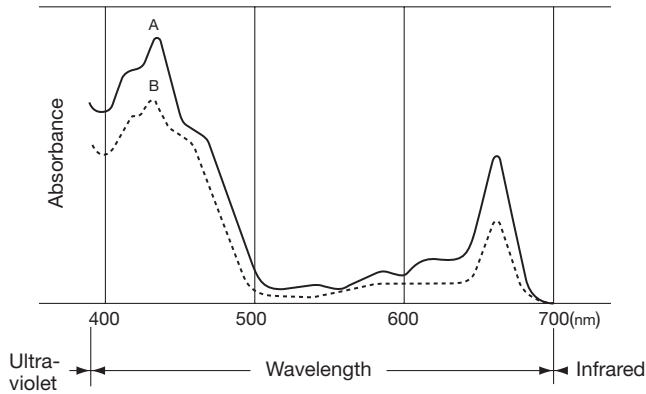

Checking the nutritional condition of plants

The chlorophyll present in the plant leaves is closely related to the nutritional condition of the plant. As can be seen from the graph below, the chlorophyll content (represented by the measured SPAD value) will increase in proportion to the amount of nitrogen (an important plant nutrient) present in the leaf. For a particular plant species, a higher SPAD value indicates a healthier plant.

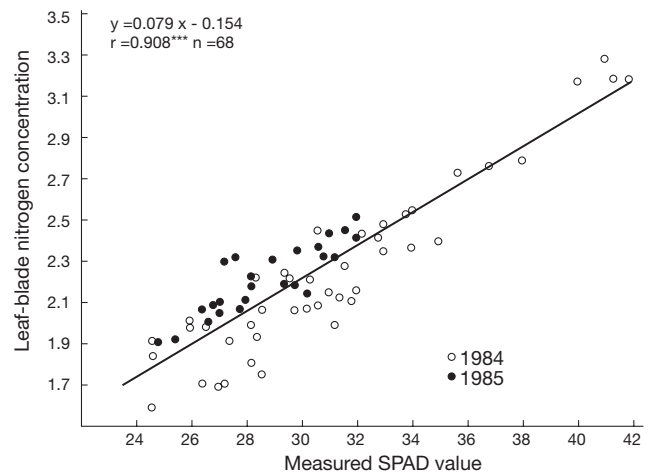

Wheat, Rice, Corn, Cotton and beyond

The SPAD-502Plus serves in a wide variety of plant applications. Through its history, the SPAD series has established itself as a leading brand in chlorophyll measurement across the world. It has been serving researchers and growers, enabling them to perform field tests quickly and easily. The SPAD series has been used for various kinds of plants and its applications are still growing.



Corn



Wheat

Trend graph display

Changes in measurement data over time can be seen, and abnormal values can be noticed at a glance.

Compact and lightweight for portability

The SPAD-502Plus is small enough to fit in a pocket and is extremely lightweight (only 200 g) so it can be easily taken anywhere.

Quick, easy measurements

Measurements are taken by simply inserting a leaf and closing the measuring head. It is not necessary to cut the leaf, so the same leaf can be measured throughout the growing process.

Water-resistant

The SPAD-502Plus is water-resistant (IPX-4), so it can be used outside even in the rain.

*It is not immersible, and should not be cleaned with water.

Low power consumption

The SPAD-502Plus uses LED light sources, resulting in extremely low power consumption. One set of two AA-size alkaline-manganese batteries can provide approximately 20,000 measurements.

Small measuring area

The measuring area is only 2 x 3 mm, allowing measurements of even small leaves. A sliding depth stop is included for accurate positioning on sample leaves.

High accuracy

High measuring accuracy (± 1.0 SPAD unit for rice-plant leaves) allows close examination of growing conditions.

Data memory

The SPAD-502Plus has memory space for 30 measurements. Data in memory can be recalled or deleted at a later time, and the average value of all data in memory can be automatically calculated.

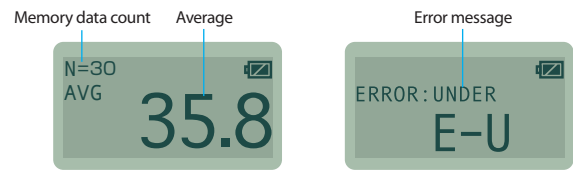

Reading checker

A reading checker enables users to check that the SPAD-502 is functioning correctly and providing accurate readings.

Names of parts

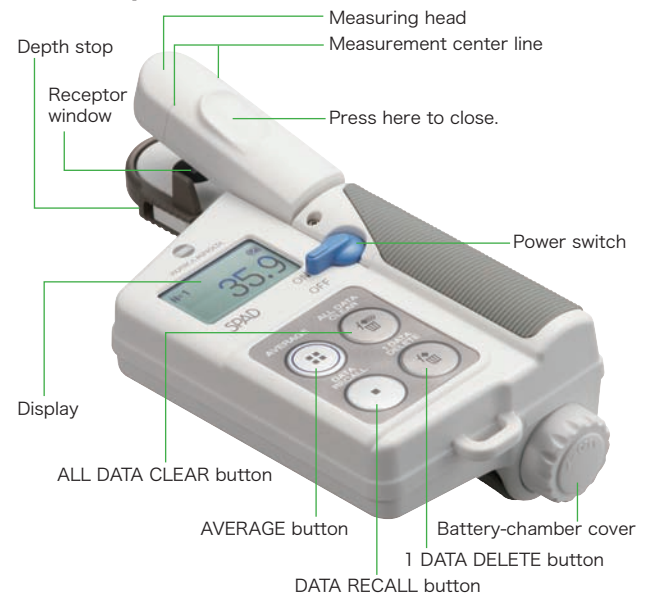

Nitrogen management

Nitrogen (N) management is a very important issue for plant growers and for the environment.

For growers, knowing the N requirement of plant enables the proper amount of N fertilizer supply to be managed.

Some experiments show that the SPAD series contributed to reductions in the use of N fertilizer by tens of percents with no loss in yield.

By optimizing the N fertilization efficiency in the field, proper N fertilizer management reduces the possibility of excessive supply of fertilizer,

which can cause diseases in plants and environmental contamination. There is increasing awareness of the need for applying the proper amount of N fertilizer in respect to water contamination in both flowing streams and underground water due to nutrient leaching through the field's soil.

The SPAD series is playing a significant role in day to day development of N fertilizer application techniques.



Rice

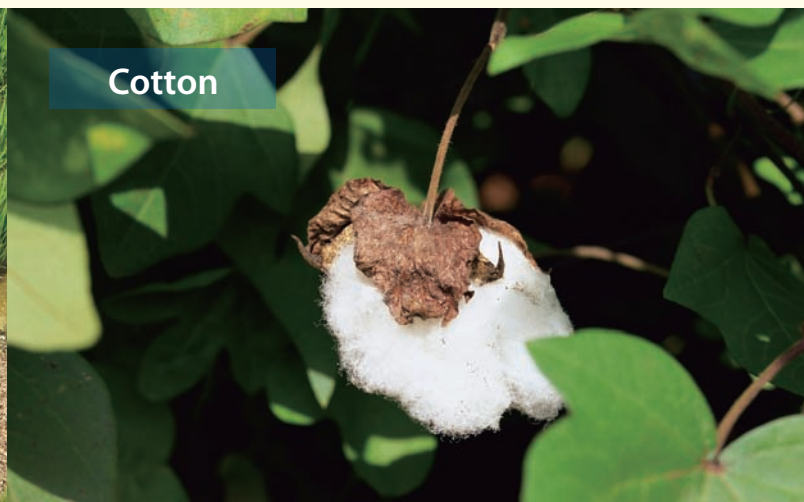

Cotton

Specifications

Type	Chlorophyll Meter SPAD-502Plus	
Measurement subject	Crop leaves	
Measurement method	Optical density difference at 2 wavelengths	
Measurement area	2 mm×3 mm	
Subject thickness	1.2 mm maximum	
Subject insertion depth	12 mm (with stopper having position adjustable from 0 to 6 mm)	
Light source	2 LED elements	
Receptor	1 SPD (silicon photodiode)	
Display	LCD panel showing 4-digit measurement value (values shown to first decimal place) and 2-digit number of measurements; Trend graph of values in memory can also be shown.	
Display range	-9.9 to 199.9 SPAD units	
Memory function	Memory capacity for up to 30 values; Calculation/display of average of data in memory also possible	
Power source	2 AA-size alkaline batteries	
Battery life	More than 20,000 measurements (when using new alkaline batteries under Konica Minolta test conditions)	
Minimum interval between measurements	Approx. 2 seconds	
Accuracy	Within ± 1.0 SPAD units (for SPAD value between 0.0 and 50.0 under normal temperature/humidity) "*" added to display when measurement exceeds 50.0 SPAD units	
Repeatability	Within ± 0.3 SPAD units	For SPAD value between 0.0 and 50.0 (with no change in sample position)
Reproducibility	Within ± 0.5 SPAD units	
Temperature drift	Within ± 0.04 SPAD units/ $^{\circ}\text{C}$	
Operating temperature/humidity range	0 to 50 $^{\circ}\text{C}$; Relative humidity of 85% or less (at 35 $^{\circ}\text{C}$) with no condensation	
Storage temperature/humidity range	-20 to 55 $^{\circ}\text{C}$; Relative humidity of 85% or less (at 35 $^{\circ}\text{C}$) with no condensation	
Size; Weight	78 (W) × 164 (H) × 49 (D) mm, 200 g (excluding batteries)	
Other	Warning buzzer; User compensation factor	
Standard accessories	Depth stop; Strap; 2 AA-size alkaline batteries; Soft case; Reading checker	

SPAD value: Index value displayed by Konica Minolta Chlorophyll meters and having a correlation to chlorophyll density.
Specifications and appearance subject to change without notice.

Dimensions

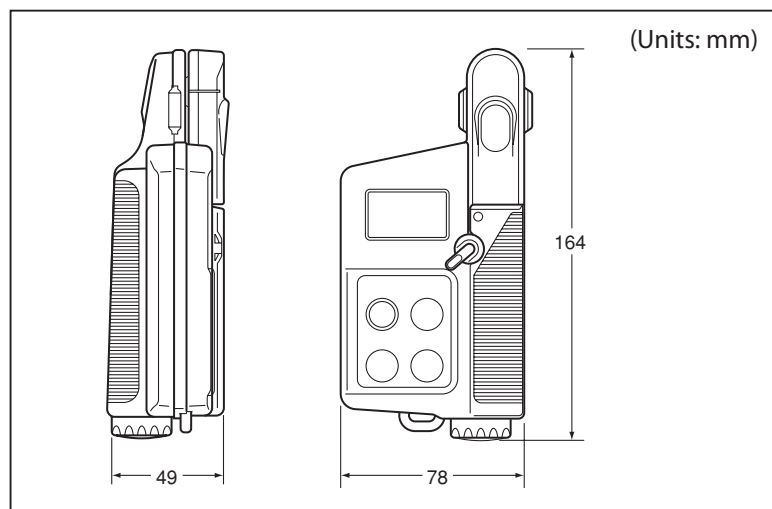

SAFETY PRECAUTIONS

 For correct use and for your safety, be sure to read the instruction manual before using the instrument.

- Be sure to use the specified battery. Using improper battery may cause a fire or electric shock.



Registration No. : YKA 0937154 Registration No. : JQA-E-80027
Registration date : March 3, 1995 Registration date : March 12, 1997

VIET NAM AGENTS :

PROCHEM (VN) TRADING CO., LTD

Add : 20, 19C, BINH TRI DONG B Ward, BINH TAN Dist, HCMC, VIET NAM

Tel : 84-8-6260 1171/ 3762 0322 ~ 23

Fax : 84-8- 3762 0010

Website: <http://www.prochem.vn>

E-Mail: prochem.viet@gmail.com